

GENERAL INFORMATION

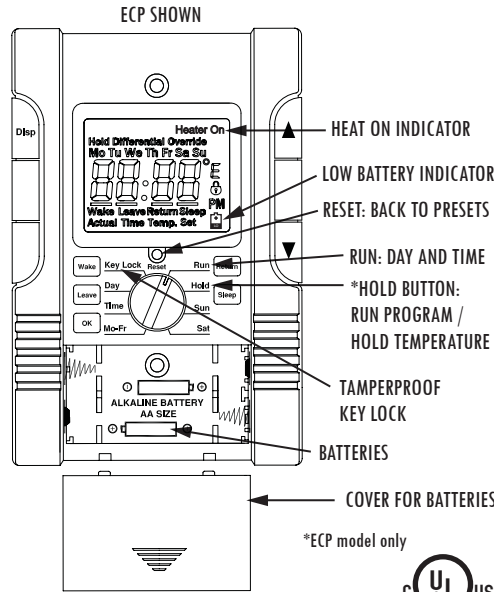

EC & ECP Series
System Matched for King heaters



SPECIFICATIONS:
 Temperature range: 40° to 93°F
 Temperature Default: 68°F
 Display Format: Liquid Crystal Display (LCD)
 Display size: Large Format
 Sample Rate: Every 60 seconds
 Delay on or off: 3 minutes
 Heat indicator: LCD "heater on"
 Relay Rating: 16 Amps inductive
 Relay: AA battery powered
 Accuracy: ± .9°F
 Maximum Amps: 16 inductive continuous
 Maximum Watts: 3840 @ 240V or 1 hp
 3328 @ 208V or ¾ hp
 1920 @ 120V or ½ hp
 Total inductive motor load combined can not exceed 16 Amps
 Minimum Watts: 0
 Power Supply: 1 to 240 Volts AC

GENERAL INFORMATION:

This thermostat is designed to provide the best temperature control for residential line voltage electric heating. For use on 120 / 208 / 240 Volt AC and a total of 16 Amps load inductive continuous.

Almost all residential application electric heaters installed as original equipment by an electrician will be 208 or 240 Volt. It is very rare and unprofessional that a home, apartment or condominium would be wired with all 120 Volt heaters. Check the voltage to make sure you have the right thermostat for your heater voltage. A 2-pole or double-wide circuit breaker at the panel indicates a 240 Volt circuit; A 1-pole or single-wide breaker indicates a 120 Volt circuit. There are some exceptions to this rule; Check with a voltmeter to determine accurate phase to phase voltage.

Be safe and smart! Electricity can cause severe injury or death if not treated with respect and caution.

This thermostat will provide years of comfort control for your family in use with small fan-driven electric heaters, baseboards, radiant ceiling or wall panel heaters, cove heaters, or any line voltage resistance heating systems that do not have an electric motor over 1/3 hp.

OPERATION:

This precision electronic thermostat uses a very sensitive thermistor near the bottom to sense room air temperature, sending the information on to the microprocessor. As the temperature drops, the information sent will indicate if heat is needed. To reduce any undesirable fast on/off cycles, the processor has a built-in delay, up to 3 minutes. This saves energy and provides the best temperature control of an area.

This thermostat requires batteries and will have a one minute back-up when replacing old batteries. *ECP only: The default program setting is 62°F set back, 70°F set up and a standard work week timing when powered up. The day and time of day can be adjusted by selecting the TIME position and using the ▲ ▼ arrow keys. For an override, the ▲ UP arrow increases temperature and the ▼ DOWN arrow reduces temperature without any need to readjust the programming.*

The thermostat may take a few hours to stabilize the room temperature; Do not be alarmed when the thermostat does not show the correct temperature immediately after installation.

INSTALLATION:

This line voltage device should be installed and serviced by a qualified electrician. The thermostat has been designed to mount to a standard 2" x 4" electrical outlet box. Leveling of the thermostat is not required. #6-32 Phillips head mounting screws are provided.

Mount the thermostat in an open area about 5 feet above the floor, avoiding outside walls as they are too cold and will inhibit the thermostat's performance. A good rule of thumb is to place the thermostat above the wall switch for that room. This works well for most bedrooms, making it very convenient to turn the heat lower upon leaving. Avoid mounting the thermostat where there may be plumbing pipes in the wall, or placing a lamp or TV too close to the thermostat. Heat from such items negatively affects the thermostat's performance.

INSTALLATION AND MAINTENANCE



EC & ECP Series

REPLACES MODELS: CALV / T4800 / T4700 / T4600 / 1A65 / 1A66 / D22 / S22 / M601 / M602 / T498 / T4398 / MD26 / WR661 / 1D22 / C901 / C902 / S2022 / TW242 / TD902 / T410 / TD942 / M7 / M402 / M512 / K601 / HE-1



DANGER

ELECTRIC SHOCK OR FIRE HAZARD

READ ALL WIRE SIZING, VOLTAGE REQUIREMENTS AND SAFETY DATA TO AVOID PROPERTY DAMAGE AND PERSONAL INJURY

DISPLAY LEGEND - EC & ECP

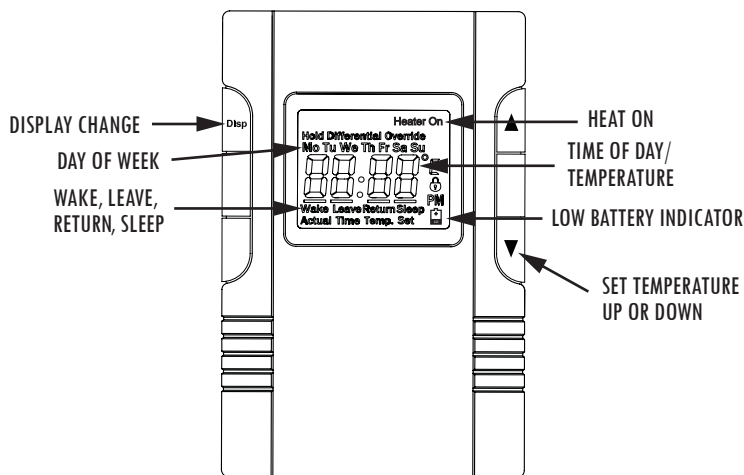

WARNING

READ CAREFULLY - These instructions were written to help prevent difficulties that might arise during thermostat installation. Studying the instructions first may save considerable time and money later. Observing the following procedures will keep installation time to a minimum. Save these instructions for future use.

Thank you for buying this King thermostat. It should provide years of service and comfort to your home. Inspect the package. Enclosed should be the thermostat with its cover and two screws.

1. Check the total load of the heaters being connecting to the thermostat. The maximum wattage at 240 Volt is 3840 Watts, 208 Volt is 3328 Watts, 120 Volt is 1920 Watts and 16 Amps/480 Watts at 30 Volt DC. It is important to stay below this total wattage when connecting the thermostat. Lower wattage prolongs the the life of the contacts in the relay.
2. To wire the thermostat determine which pair of wires are coming from the breaker panel and which pair lead to the heater.
3. Remove cover of thermostat by placing thumb on LCD display and fingers on top edge of cover. Pull towards you. This will expose the top mounting screw. Put thumb on the lower part of the battery cover and pull down to expose mounting screw and battery compartment.
4. There may be a pair of white wires connected in your junction box. If so, leave them alone and work with the black wires. If there is only a black wire and white wire use them - this is called a **switch leg** (see wiring diagram).
5. Take a black lead and attach it to the black lead on the thermostat.
6. Take the other black heater lead (white if **switch leg**) and attach it to the red lead on the thermostat. This will provide power to the heater when the thermostat calls for heat.
7. Push the wires carefully into the junction box making sure no wires are pinched or will obstruct the screws mounting the thermostat. Now attach the thermostat to the wall using the #6-32 Phillips head screws provided. Replace cover. Do not over tighten screws.
8. Install AA batteries to start display. Replace cover. **Batteries operate relay and display only**; they are not charged by voltage power and should last one year. A half-filled battery shape icon saying "Lo" will appear on the LCD to indicate battery replacement is necessary.
9. Turn on power. Test by increasing set point to higher than current room temperature by tapping the ▲ Up button. There will be up to a 3 minute delay in turning on. You will hear a small click and "Heater On" will appear in the LCD; the heater should be on now. Turn the thermostat down by tapping on the ▼ Down arrow.
10. You have now verified the thermostat is in perfect working order and ready for years of trouble-free operation.
11. **Mounting tips:** Make sure nothing is nearby (a.g. plumbing pipes in the wall, a lamp close by, direct sunlight, a T.V. set, and/or cold drafts from a door opening) that could affect the average room temperature sensing of the thermostat. Typically the best, most convenient location is on inside walls above the light switch for that room.
12. **Cleaning:** Canned compressed air works great to clear any dust accumulation, while a damp cloth will additionally clean the plastic case surface of finger prints. Strong spray cleaners may damage the plastic case or remove writing or arrows screen-printed on case. Blow out any dust that may accumulate on top or bottom air vents. Good air circulation is key to long life and accurate operation.
13. **Humid locations:** Mildly humid location like bathrooms may reduce life due to corrosion on the contact and lint from towels getting into thermostat air vents. To extend life blow out vent regularly and mount thermostat away from shower locations.

WIRING INSTRUCTIONS



EC & ECP Series

System Matched for King heaters

⚠ DANGER ⚠

ELECTRIC SHOCK OR FIRE HAZARD

READ ALL WIRE SIZING, VOLTAGE REQUIREMENTS AND SAFETY DATA TO AVOID PROPERTY DAMAGE AND PERSONAL INJURY

- To wire the thermostat determine which pair of wires are coming from the breaker panel and which pair lead to the heater.
- Take a black lead from the circuit breaker panel and attach it to the black lead on the thermostat.
- Take the black lead that goes to the heater and attach it to the red lead on the thermostat. This will provide power to the heater when the thermostat calls for heat.
- Remove cover of thermostat by placing thumb on LCD display and forefinger on top of cover, pulling cover back to expose mounting screws and programming buttons. Slide battery cover off to expose lower mounting screw.
- Push the wires carefully into the junction box making sure no wires are pinched or obstruct the screws mounting the thermostat. Now attach the thermostat to the wall with the #6-32 Phillips head screws provided.
- Hold thermostat in wallbox and place screws in top and bottom mounting hole. Attach to wallbox. Install batteries and replace cover.
- Turn on power. Test by increasing set point to higher than room temperature by tapping the ▲ Up button. There will be up to a 3 minute delay turning on. You will hear a small click and "Heater On" will appear on the LCD; the heater should now be on. Turn the thermostat down by tapping on the ▼ Down arrow.
- Differential Adjustment:** Hold both temperature ▲ and ▼ buttons for 10 seconds. The screen will go blank then show one digit. This is the number of degrees that the thermostat will over or undershoot the desired temperature. Adjust the setting between 1° and 4° by tapping the ▲ or ▼ arrow. Adjust to suit your comfort level.

* To change the display from Fahrenheit to Celsius requires opening the thermostat and moving a small jumper on circuit board. For assistance please contact the factory at (800) 603-5464 ext. 111

DIMENSIONS:

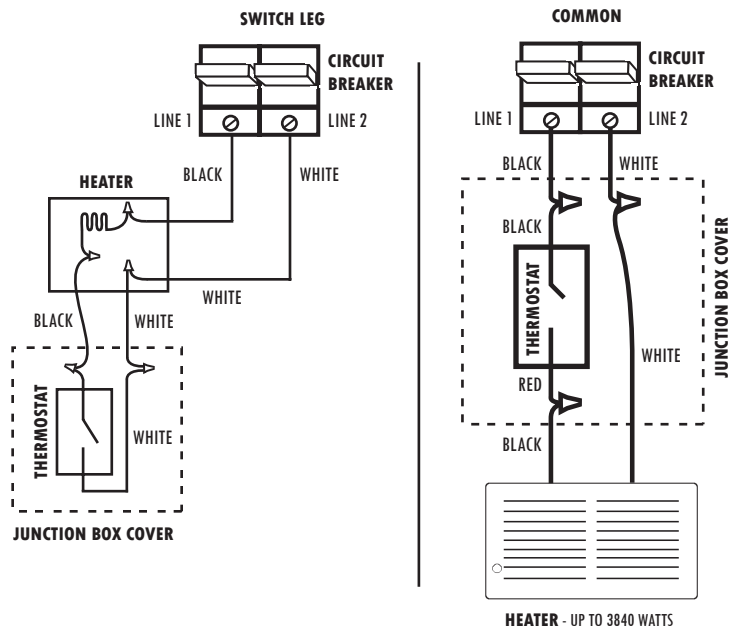
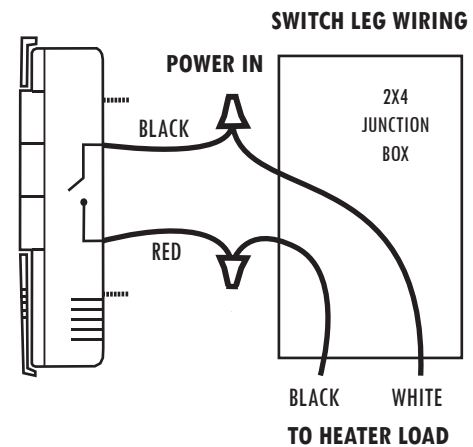
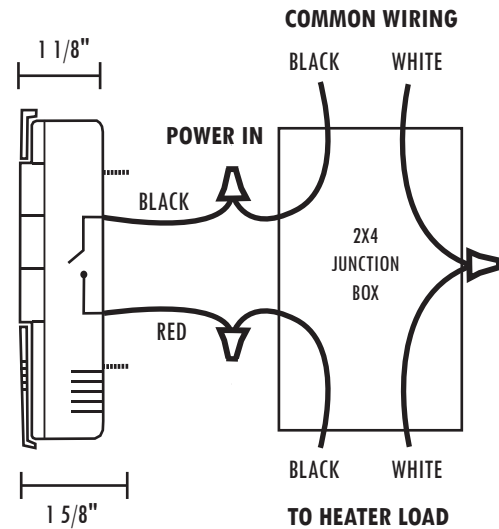
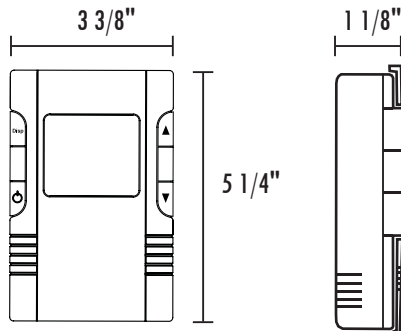



ECP PROGRAMMING INSTRUCTIONS



1 Set Day and Time

- Turn switch to "DAY".
- Use ▼ or ▲ to set day of the week.
- Turn switch to "TIME".
- Use ▼ or ▲ to set hour and minute.

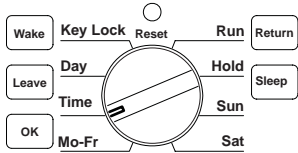
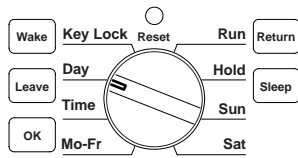

2 Set To Run

- Morning wake-up program
- Daily away from home program
- Evening home program
- Nightly sleep program

- Turn switch to "Mo-Fr" (Monday - Friday).
- Press to set first program-period of weekday.
- Use ▼ or ▲ to set time for .
- Press to set temperature setpoint.
- Use ▼ or ▲ to set temperature.

Pressing will alternate the display between time and temperature settings for all 4 buttons.

- Press to set second program-period of weekday.
- Follow steps 3 - 5 to complete programming.
- Press to set third program-period of weekday.
- Follow steps 3 - 5 to complete programming.
- Press to set fourth program-period of weekday.
- Follow steps 3 - 5 to complete programming.
- Turn switch to "SAT" (Saturday).
- Follow steps 3 - 5 to complete Saturday programming.
- Turn switch to "SUN" (Sunday).
- Follow steps 3 - 5 to complete Sunday programming.

Default Energy Star Schedule

Program	Temp.	Mo-Su
Wake	70°	6:00am
Leave	62°	8:00am
Return	70°	6:00pm
Sleep	62°	10:00pm

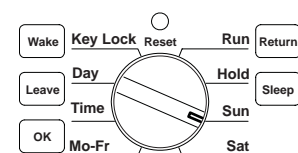
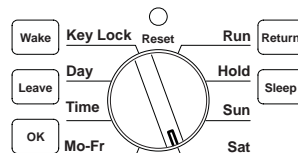
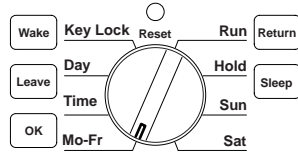

"ERR" will show if no data is input after 10 minutes. To continue, turn switch to "RUN" then back to previous position.

3 Adjusting the Differential

- Turn switch to "RUN" to operate.
- Press ▼ and ▲ together for 8 seconds.
- Use either ▼ or ▲ to set differential.
- The thermostat will memorize and use the new setting after 5 seconds.

Wattage	Suggested Differential
100 to 1000W	1°
1200 to 2000 W	2°
2000 to 2750 W	3°
3000 to 3840W	4°

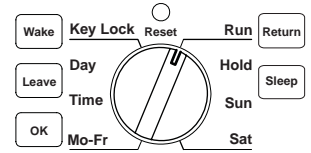

4 Override Function

This thermostat provides 2 manual temperature overrides.

TEMPORARY temperature change

- Turn switch to "RUN".
- Use ▼ or ▲ to change temperature setting.
- The thermostat will memorize and use the new temperature setting after 5 seconds or until the next time-temperature begins.
- To end the temporary override turn the switch away from "RUN" then back.

PERMANENT on HOLD temperature setting

- Turn switch to "HOLD".
- Use ▼ or ▲ to change temperature setting.
- The thermostat will use the new setting after 5 seconds until the user manually ends it.
- To end the permanent on hold override turn the switch away from "HOLD" to "RUN" or "Key Lock".

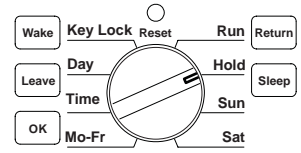

Key Lock

This deactivates buttons on the front panel. Temperature can not be changed without switching back to RUN.

5 Your Schedule

Program	Monday - Friday		Saturday		Sunday	
	Time	Temp.	Time	Temp.	Time	Temp.
Wake	:	°F	:	°F	:	°F
Leave	:	°F	:	°F	:	°F
Return	:	°F	:	°F	:	°F
Sleep	:	°F	:	°F	:	°F

6 Display Options / TAP Display Button

DISPLAY

- Room Temperature / Day and Time / Setpoint Temperature Alternating
- Room Temperature Only / No Alterations

7 Batteries

- LCD display and relay are battery powered, not charged by line voltage. One year life is expected.
- "BAT LO" showing on the LCD indicates time to replace the batteries.