

GENERAL INFORMATION



H30 & HP30 Series 2 Circuit Control

⚠ DANGER ⚠

ELECTRIC SHOCK OR FIRE HAZARD

READ ALL WIRE SIZING, VOLTAGE REQUIREMENTS AND SAFETY DATA TO AVOID PROPERTY DAMAGE AND PERSONAL INJURY

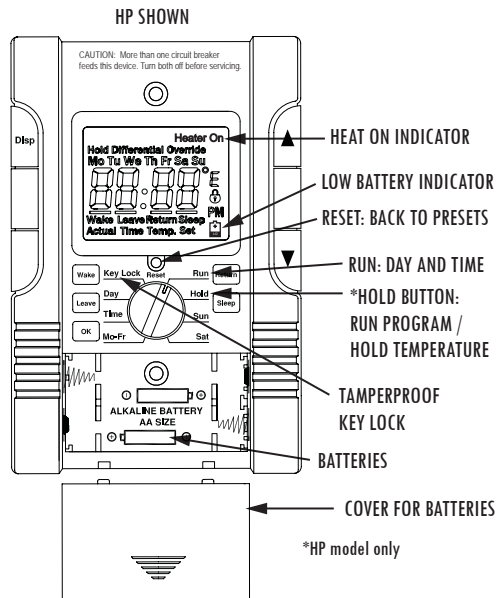

SPECIFICATIONS:

Temperature range: 40° to 95°F

Temperature Default: Program

Display Format: Liquid Crystal Display (LCD)

Display size: Large Format

Sample Rate: Every 60 seconds

Delay on: 1 second for relay 2

Heat indicator: LCD "heater on"

Relay Rating: 16 Amps per relay

Relay: AA battery powered

Accuracy: ± .9°F

Maximum Amps: 16 resistive or inductive

Maximum Watts: 7700 @ 240V
6656 @ 208V
3840 @ 120V

Minimum Watts: 0

Power Supply: 1 to 240 Volts AC
1 to 30 Volts DC

GENERAL INFORMATION:

This thermostat is designed to provide the best room temperature control for residential heating. For use on 120 / 208 / 240 Volt AC or up to 30 Volts DC and a total of 16 Amps per pole and controls two electrical circuits at the same time.

Be safe and smart! Electricity can cause severe injury or death if not treated with respect and caution.

This thermostat will provide years of comfort control for your family in use with electric heaters that need a two circuit control.

OPERATION:

This precision electronic thermostat uses a very sensitive thermistor near the bottom to sense room air temperature, sending the information on to the microprocessor. As the temperature drops, the information sent will indicate if heat is needed. To reduce any undesirable fast on/off cycles, the processor has a built-in delay, up to 3 minutes. This saves energy and provides the best temperature control of an area. The thermostat will control two circuits of heaters until the room reaches temperature, then shutting off waiting for the room temperature to drop again.

This thermostat requires batteries and will have a one minute back-up when replacing old batteries. *HP only:* The default program setting is 62°F set back, 70°F set up and a standard work week timing when powered up. The day and time of day can be adjusted by selecting the TIME position and using the ▲ ▼ arrow keys. For temperature override, the ▲ Up arrow increases temperature and the ▼ Down arrow reduces temperature without any need to readjust the programming.

The thermostat may take a few hours to stabilize to the room temperature; Do not be alarmed when the thermostat does not show the correct temperature immediately after installation.

INSTALLATION:

This line voltage device should be installed and serviced by a qualified electrician. The thermostat has been designed to mount to a standard 2" x 4" electrical outlet box. Leveling of the thermostat is not required. #6-32 Phillips head mounting screws are provided and captive ready to install.

Mount the thermostat in an open area about 5 feet above the floor, avoiding outside walls as they are too cold and will inhibit the thermostat's performance. A good rule of thumb is to place the thermostat above the wall switch for that room. This works well for most bedrooms, making it very convenient to turn the heat lower upon leaving. Avoid mounting the thermostat where there may be plumbing pipes in the wall, or placing a lamp or TV too close to the thermostat. Heat from such items negatively effects the thermostat's performance.

DIFFERENTIAL:

This thermostat has a user adjustable differential between 1° and 4°. Press HOLD and the temperature ▲ Up and ▼ Down arrows at the same time for 5 seconds. Then press the up or down to adjust the differential. You can experiment with different settings until you find the one that best controls your space. Suggested settings are in the programming instructions.

CAUTION: More than one circuit breaker feeds this device. Turn off both before installing or servicing.

INSTALLATION AND MAINTENANCE



H30 & HP30 Series 2 Circuit Control



DANGER

ELECTRIC SHOCK OR FIRE HAZARD

READ ALL WIRE SIZING, VOLTAGE REQUIREMENTS AND SAFETY DATA TO AVOID PROPERTY DAMAGE AND PERSONAL INJURY

DISPLAY LEGEND - H & HP*

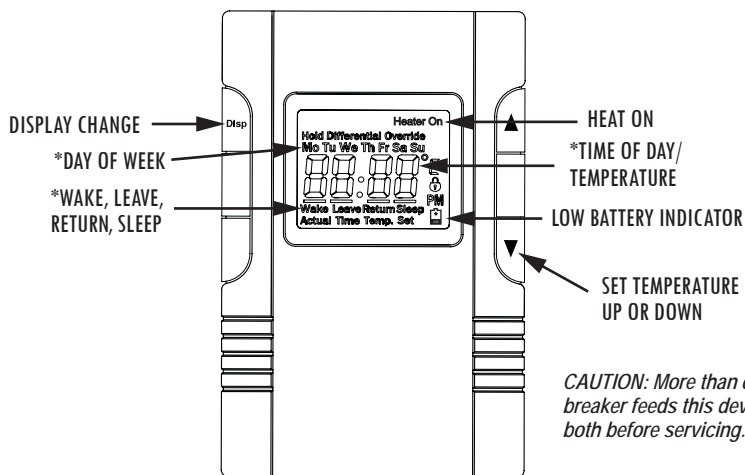

CAUTION: More than one circuit breaker feeds this device. Turn off both before servicing.

WARNING

READ CAREFULLY - These instructions were written to help prevent difficulties that might arise during thermostat installation. Studying the instructions first may save considerable time and money later. Observing the following procedures will keep installation time to a minimum. Save these instructions for future use.

Thank you for buying this King thermostat. It should provide years of service and comfort to your home. Inspect the package. Enclosed should be the thermostat with its cover and two screws.

1. Check the total load of the load being connecting to the thermostat. The maximum wattage per pole at 240 Volt is 3840 Watts, 208 Volt is 3328 Watts, 120 Volt is 1920 Watts and 16 Amps/480 Watts at 30 Volt DC per switch. It is important to stay below this total wattage when connecting the thermostat. Lower wattage prolongs the the life of the contacts in the relay.
2. To wire the thermostat determine which wires are coming from the breaker panel and which wires lead to the heater wire per diagram.
3. Remove cover of thermostat by placing thumb on LCD display and fingers on top edge of cover. Pull towards you. This will expose the top mounting screw. Put thumb on the lower part of the battery cover and pull down to expose mounting screw and battery compartment.
4. There may be a pair of white wires connected in your junction box. If so, leave them alone and work with the black wires.
5. Take a black power lead and attach it to the yellow lead on the thermostat. Repeat for the other black lead but attach to red lead on thermostat.
6. Attach the black leads that feed the heater to the remaining red and yellow leads. Both circuits will be controlled by one thermostat. Make sure you have the proper phases together by using a voltmeter.
7. Push the wires carefully into the junction box making sure no wires are pinched or will obstruct the screws mounting the thermostat. Now attach the thermostat to the wall using the #6-32 Phillips head screws provided. Do not over tighten screws.
8. Install AA batteries to start display. Replace cover. **Batteries operate relay and display only**, they are not charged by line voltage power and should last one year. A half-filled battery shape icon saying "Lo" will appear on the LCD to indicate battery replacement is necessary.
9. Turn on power. Test by increasing set point to higher than current room temperature by tapping the ▲ Up button. There will be up to a 3 minute delay in turning on. You will hear a small click and "Heater On" will appear in the LCD; the heater should be on now. Turn the thermostat down by tapping on the ▼ Down arrow. You will hear a small click and the heater will be off.
10. You have now verified the thermostat is in perfect working order and ready for years of trouble-free operation.
11. **Mounting tips:** Make sure nothing is nearby (plumbing pipes in the wall, a lamp close by, direct sunlight, a T.V. set, and/or cold drafts from a door opening) that could affect the average room temperature sensing of the thermostat. Typically the best, most convenient location is on inside walls above the light switch for that room. Do not install on an outside wall if possible.
12. **Cleaning:** Canned compressed air works great to clear any dust accumulation, while a damp cloth will additionally clean the plastic case surface of finger prints. Strong spray cleaners may damage the plastic case or remove writing or arrows screen-printed on buttons. Blow out any dust that may accumulate on top or bottom air vents. Good air circulation is key to long life and accurate operation.
13. **Humid locations:** Mildly humid location like bathrooms may reduced life due to corrosion on the contact and lint from towels getting into thermostat air vents. To extend life blow out vent regularly and mount thermostat away from shower locations or other high humidity areas.

WIRING INSTRUCTIONS



H30 & HP30 Series 2 Circuit Control

⚠ DANGER ⚠

ELECTRIC SHOCK OR FIRE HAZARD

READ ALL WIRE SIZING, VOLTAGE REQUIREMENTS AND SAFETY DATA TO AVOID PROPERTY DAMAGE AND PERSONAL INJURY

1. To wire the thermostat determine which pair of wires are coming from the breaker panel and which wire leads to the heaters.
2. Take a black lead from the circuit breaker panel and attach it to the yellow lead on the thermostat. This provides power to one relay and controls one circuit. Repeat for other black lead but attach to red lead. Make sure you have the right phase.
3. Take the lead that goes to the heater and attach it to the red lead on the thermostat. Repeat for other yellow lead checking phase with voltmeter.
4. Remove cover of thermostat by placing thumb on LCD display and forefinger on top of cover, pulling cover back to expose mounting screws and programming buttons. Slide battery cover off to expose lower mounting screw.
5. Push the wires carefully into the junction box making sure no wires are pinched or obstruct the screws mounting the thermostat. Now attach the thermostat to the wall with the #6-32 Phillips head screws captive and ready to install.
6. Hold thermostat on wallbox and screw in top and bottom mounting hole. Attach to wallbox. Install batteries and replace cover.
7. TESTING: Test by increasing set point to higher than room temperature by tapping the ▲ Up button. There will be up to a 3 minute delay in turning on. You will hear a small click and "Heater On" will appear on the LCD; the heater should now be on. Turn the thermostat down by tapping on the ▼ Down arrow.
8. **Differential Adjustment:** Hold both temperature ▲ Up and ▼ Down buttons for 5 seconds. The screen will go blank then show one digit. This is the number of degrees that the thermostat will over or undershoot the desired temperature. Adjust the setting between 1° and 4° by tapping the ▲ Up or ▼ Down arrow. Adjust to suit your comfort level. Customarily the higher wattage heater needs a higher degree of anticipation.

* To change the display from Fahrenheit to Celsius requires opening the thermostat and applying a small jumper on circuit board. For assistance please contact the factory at (800) 603-5464 ext. 111

DIMENSIONS:

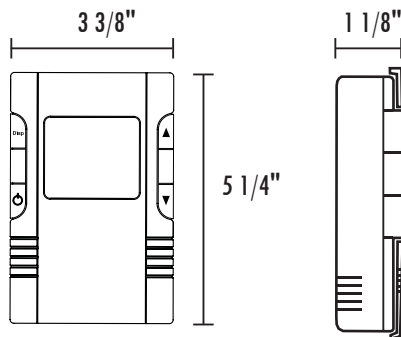

CAUTION: More than one circuit breaker will need to be turned off in order to install or service this thermostat.

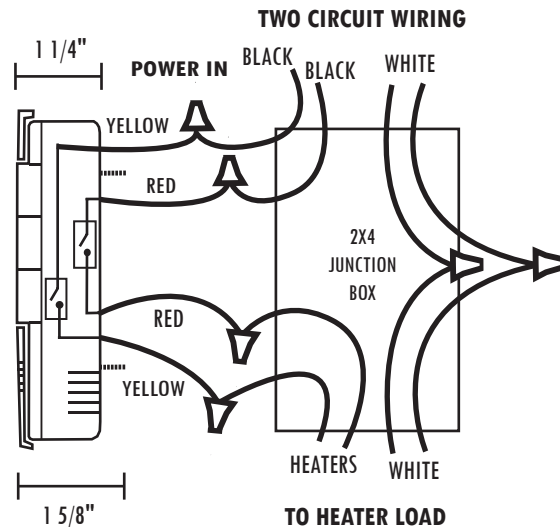

NOTE: When wiring verify proper phase with a voltmeter for each circuit.

2 Independent 2-Pole Breakers

OPERATION SCHEMATIC

TWO CIRCUIT
16 AMPS MAX.
PER CIRCUIT

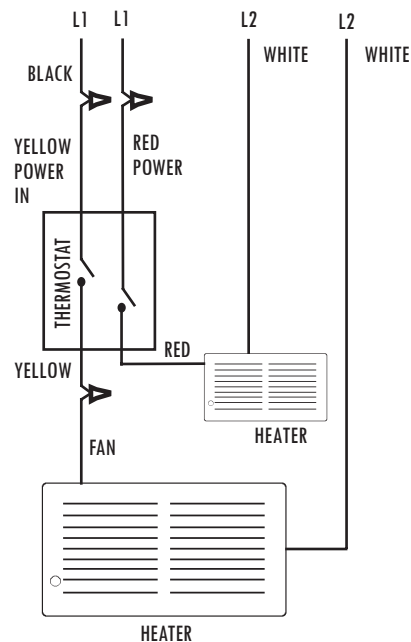



HP30 PROGRAMMING INSTRUCTIONS

CAUTION: More than one circuit breaker feeds this device. Turn both off before servicing.



TWO CIRCUIT CONTROL

1 Set Day and Time

- Turn switch to "DAY".
- Use ▼ or ▲ to set day of the week.
- Turn switch to "TIME".
- Use ▼ or ▲ to set hour and minute.

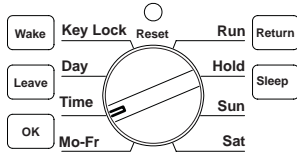
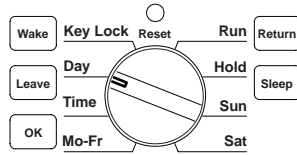

2 Set To Run

- Morning wake-up program
- Daily away from home program
- Evening home program
- Nightly sleep program

- Turn switch to "Mo-Fr" (Monday - Friday).
- Press **Wake** to set first program-period of weekday.
- Use ▼ or ▲ to set time for **Wake**.
- Press **OK** to set temperature setpoint.
- Use ▼ or ▲ to set **Wake** temperature.

Pressing **OK** will alternate the display between time and temperature settings for all 4 buttons.

- Press **Leave** to set second program-period of weekday.
- Follow steps 3 - 5 to complete **Leave** programming.
- Press **Return** to set third program-period of weekday.
- Follow steps 3 - 5 to complete **Return** programming.
- Press **Sleep** to set fourth program-period of weekday.
- Follow steps 3 - 5 to complete **Sleep** programming.
- Turn switch to "SAT" (Saturday).
- Follow steps 3 - 5 to complete Saturday programming.
- Turn switch to "SUN" (Sunday).
- Follow steps 3 - 5 to complete Sunday programming.

Default Energy Star Schedule

Program	Temp.	Mo-Su
Wake	70°	6:00am
Leave	62°	8:00am
Return	70°	6:00pm
Sleep	62°	10:00pm

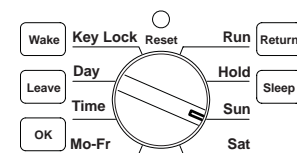
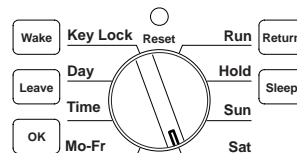
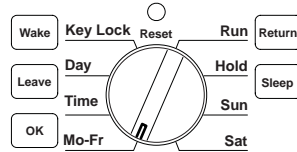

"ERR" will show if no data is input after 10 minutes. To continue, turn switch to "RUN" then back to previous position.

3 Adjusting the Differential

- Turn switch to "RUN" to operate.
- Press ▼ and ▲ together for 5 seconds.
- Use either ▼ or ▲ to set differential.
- The thermostat will memorize and use the new setting after 5 seconds.

Watts	Suggested Differential
250 to 2,500	1°
2,750 to 3,500	2°
3,750 to 5,500	3°
5,750 to 7,700	4°

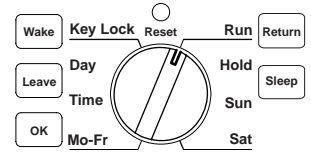

4 Override Function

This thermostat provides 2 manual temperature overrides.

TEMPORARY temperature change

- Turn switch to "RUN".
- Use ▼ or ▲ to change temperature setting.
- The thermostat will memorize and use the new temperature setting after 5 seconds or until the next time-temperature begins.
- To end the temporary override turn the switch away from "RUN" then back.

PERMANENT on HOLD temperature setting

- Turn switch to "HOLD".
- Use ▼ or ▲ to change temperature setting.
- The thermostat will use the new setting after 5 seconds until the user manually ends it.
- To end the permanent on hold override turn the switch away from "HOLD" to "RUN" or "Key Lock".

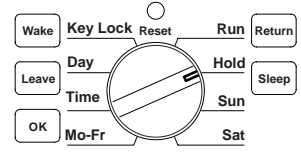

Key Lock

This deactivates buttons on the front panel. Temperature can not be changed without switching back to RUN.

5 Your Schedule

Program	Monday - Friday		Saturday		Sunday	
	Time	Temp.	Time	Temp.	Time	Temp.
Wake	:	°F	:	°F	:	°F
Leave	:	°F	:	°F	:	°F
Return	:	°F	:	°F	:	°F
Sleep	:	°F	:	°F	:	°F

6 Display Options / TAP Display Button

DISPLAY

- Room Temperature / Day and Time / Setpoint Temperature Alternating
- Room Temperature Only / No Alterations

7 Batteries

- LCD display and relay are battery powered, not charged by line voltage. One year life is expected.
- "BAT LO" showing on the LCD indicates time to replace the batteries.