

INSTALLATION AND MAINTENANCE



WINDOW WATCHER™

WR230 & WRP230 Series

⚠ DANGER ⚠

ELECTRIC SHOCK OR FIRE HAZARD

READ ALL WIRE SIZING, VOLTAGE REQUIREMENTS AND SAFETY DATA TO AVOID PROPERTY DAMAGE AND PERSONAL INJURY

DISPLAY LEGEND - WR & WRP

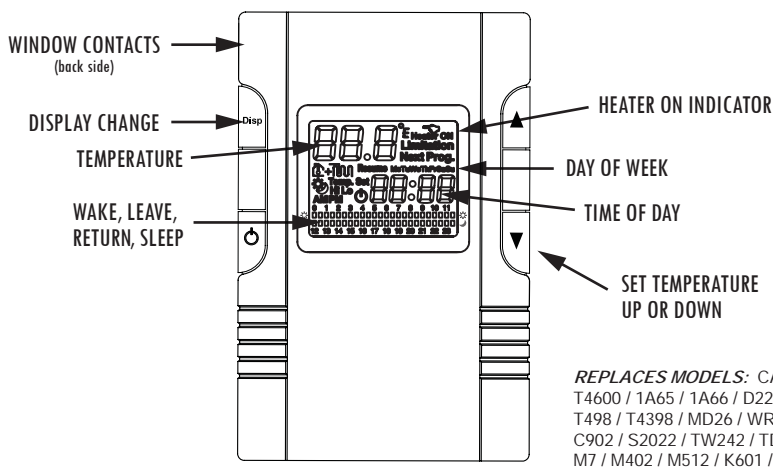

⚠ WARNING ⚠

READ CAREFULLY - These instructions were written to help prevent difficulties that might arise during thermostat installation. Studying the instructions first may save considerable time and money later. Observing the following procedures will keep installation time to a minimum. Save these instructions for future use.

Thank you for buying this King WINDOW WATCHER™ thermostat. This thermostat is designed to reinforce positive energy habits while limiting landlord energy expenses. It should provide years of service and comfort to your home. Inspect the package. Enclosed should be the thermostat with its cover and two screws.

1. Check the total load of the heaters being connecting to the thermostat. The maximum wattage at 240 Volt is 3840 Watts, 208 Volt is 3328 Watts, and 16 Amps. It is important to stay below this total wattage when connecting the thermostat. Lower wattage prolongs the the life of the contacts in the relay.
2. To wire the thermostat determine which pair of wires are coming from the breaker panel and which pair lead to the heater. *See Wiring Instructions.*
3. Remove cover of thermostat by placing thumb on LCD display and fingers on top edge of cover. Pull towards you. This will expose the top mounting screw.
4. There may be a pair of white wires connected in your junction box. If so, leave them alone and, at this time, work with the black wires.
5. Take a black lead from the circuit breaker panel and attach it to the black lead on the thermostat.
6. Take the other black heater lead and attach it to the red lead on the thermostat. This will provide power to the heater when the thermostat calls for heat. Add blue wire to both white wires to provide power to electronics.
7. Push the wires carefully into the junction box making sure no wires are pinched or will obstruct the screws mounting the thermostat. Now attach the thermostat to the wall using the #6-32 Phillips head screws provided. Replace cover. Do not over tighten screws.
8. Replace cover after setting time and programming.
9. Turn on power. Test by increasing set point to higher than current room temperature by tapping the ▲ Up button. There will be up to a 3 minute delay in turning on. You will hear a small click and "Heater On" will appear in the LCD; the heater should be on now. Turn the thermostat down by tapping on the ▼ Down arrow.
10. You have now verified the thermostat is in perfect working order and ready for years of trouble-free operation.
11. **Mounting tips:** Make sure nothing is nearby (a.g. plumbing pipes in the wall, a lamp close by, direct sunlight, a T.V. set, and/or cold drafts from a door opening) that could affect the average room temperature sensing of the thermostat. Typically the best, most convenient location is on inside walls above the light switch for that room.
12. **Cleaning:** Canned compressed air works great to clear any dust accumulation, while a damp cloth will additionally clean the plastic case surface of finger prints. Strong spray cleaners may damage the plastic case or remove writing or arrows screen-printed on case. Blow out any dust that may accumulate on top or bottom air vents. Good air circulation is key to long life and accurate operation.
13. **Humid locations:** Mildly humid location like bathrooms may reduce life due to corrosion on the contact and lint from towels getting into thermostat air vents. To extend life blow out vent regularly and mount thermostat away from shower locations.
14. **Purpose:** This thermostat is designed to reinforce positive energy habits while limiting landlord energy expenses.

WIRING INSTRUCTIONS



WINDOW WATCHER™

WR & WRP Series

System Matched for King heaters

⚠ DANGER ⚠

ELECTRIC SHOCK OR FIRE HAZARD

READ ALL WIRE SIZING, VOLTAGE REQUIREMENTS AND SAFETY DATA TO AVOID PROPERTY DAMAGE AND PERSONAL INJURY

- To wire the thermostat determine which pair of wires are coming from the breaker panel and which pair lead to the heater.
- Take a black lead from the circuit breaker panel and attach it to the black lead on the thermostat.
- Take the black lead that goes to the heater and attach it to the red lead on the thermostat. This will provide power to the heater when the thermostat calls for heat. Attach the blue wire to the white wires.
- Remove cover of thermostat by placing thumb on LCD display and forefinger on top of cover, pulling cover back to expose mounting screws and programming buttons. Slide battery cover off to expose lower mounting screw.
- Push the wires carefully into the junction box making sure no wires are pinched or obstruct the screws mounting the thermostat. Now attach the thermostat to the wall with the #6-32 Phillips head screws provided.
- Hold thermostat in wallbox and place screws in top and bottom mounting hole. Attach to wallbox. Install batteries and replace cover.
- Turn on power. Test by increasing set point to higher than room temperature by tapping the ▲ Up button. There will be up to a 3 minute delay turning on. You will hear a small click and "Heater On" will appear on the LCD; the heater should now be on. Turn the thermostat down by tapping on the ▼ Down arrow.
- Differential Adjustment:** Hold both temperature ▲ and ▼ buttons for 10 seconds. The screen will go blank then show one digit. This is the number of degrees that the thermostat will over or undershoot the desired temperature. Adjust the setting between 1° and 4° by tapping the ▲ or ▼ arrow. Adjust to suit your comfort level.

* To change the display from Fahrenheit to Celsius requires opening the thermostat and moving a small jumper on circuit board. For assistance please contact the factory at (800) 603-5464 ext. 111

The small 22 gauge wire connection on the back of the thermostat is for the remote 40° activation. This is a volt-free set of control wires that can be used with any switch, such as: window and door contacts, motion sensors, key cards, hotel panels, anything that can make or break contact.

40° set back is activated on contact open.



PATENT APPLIED FOR

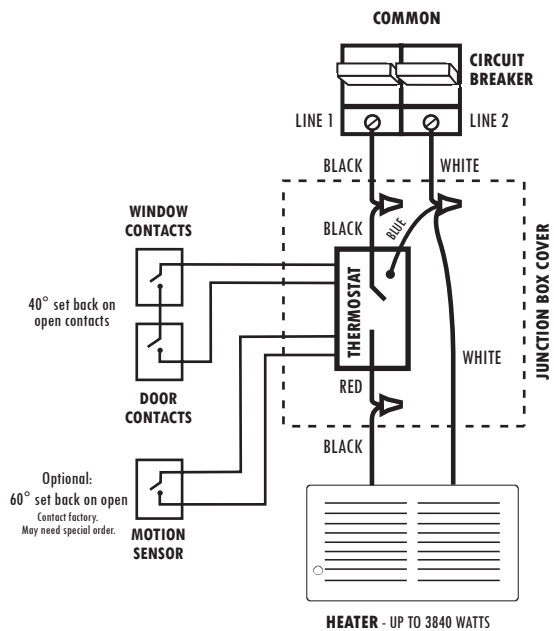
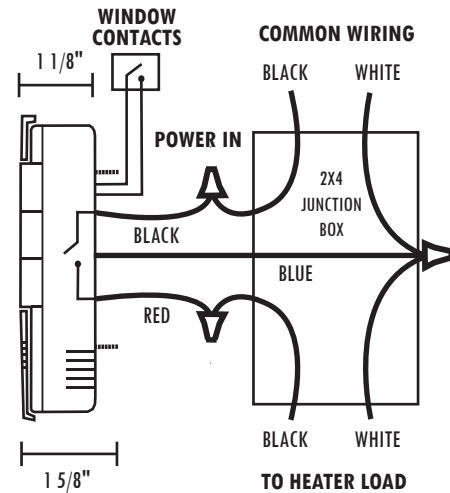

DIMENSIONS:

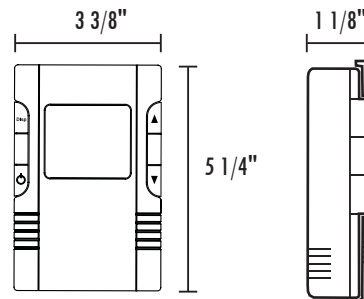

WRP230 WINDOW WATCHER™ PROGRAMMING INSTRUCTIONS



PATENT APPLIED FOR

1 Comfort ☀️ and Economy 🌙 Setting

To adjust setup (comfort) and setback (economy) temperatures.

- 1 Turn rotary switch to START.
- 2 Press twice to enter room temperature "HI" (comfort) setpoint. Press ▼ or ▲ to adjust. Press to exit.
- 3 Press twice to enter room temperature "LO" (economy) setpoint. Press ▼ or ▲ to adjust. Press to exit.
- 4 Wait 5 seconds after adjusting the temperature. The thermostat shall memorize setting and return to the main screen.

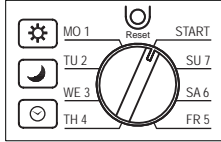

This thermostat has only two air temperature settings: 7 independent days and 30 minute increments. Users can adjust Comfort ☀️ and Economy 🌙 time to their schedule many times per day.

2 Clock

- 1 Turn indicator on rotary switch to "START".
- 2 Press to enter clock programming.
- 3 Press ▼ or ▲ to select the day of the week.
- 4 Press again to adjust hour of day.
- 5 Repeat pressing and ▼ ▲ to finishing setting the time.
- 6 LCD display shall automatically memorize the setting and return to the main screen 5 seconds after time is set.

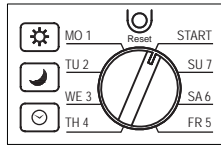

3 Independent Daily Time Schedule Setting

If the dial is left in anything but the START position it will default to "ERR" (Error). Turn to START to clear Error and restart programming.

Factory default settings are 70°F/21°C ☀️ and 61°F/16°C 🌙.

- 1 Turn indicator on rotary switch to the desired week day to begin programming time.
- 2 Press or to alter the setting between ☀️ and 🌙 on the LCD display.
- 3 Press ▼ or ▲ to select each individual time schedule. Each time schedule will be indicated by flashing symbols.
- 4 After setting all 7 days of the week turn rotary switch to "START". The thermostat will now start to operate its program.

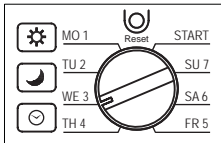

4 Hold

Press "HOLD" for constant temperature. 40° window switch can still override.

5 Manual (Temporary Override)

- 1 Turn indicator on rotary switch to "START".
- 2 Press ▼ or ▲ to indicate current ☀️ or 🌙 temperature settings.
- 3 Press ▼ or ▲ to adjust temperature setting.
- 4 The LCD display will flash for approximately 8 seconds after temperature setting is complete then return to the main LCD display screen. The thermostat will now begin to execute the Manual function.
- 5 Turn the rotary switch away from "START" then turn it back to "START" to terminate the Manual function.

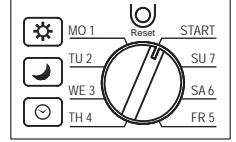

When in Comfort ☀️ while setting the Manual function the thermostat will maintain executing Manual until the program runs to Economy 🌙. The same is true in Economy 🌙.

The ☀️ and 🌙 icons will disappear from the LCD at the section of time the Manual function is operating.

5 WINDOW WATCHER™ mode

Any remote contacts can be used to activate the 40° set back. Multiple contacts can be placed in series so that if any break in the small 22 gauge control wire is sensed the thermostat will display "OFF" on the LCD window. As soon as the window contacts are closed the thermostat will resume operating like normal (the previous setting before the contacts were opened).

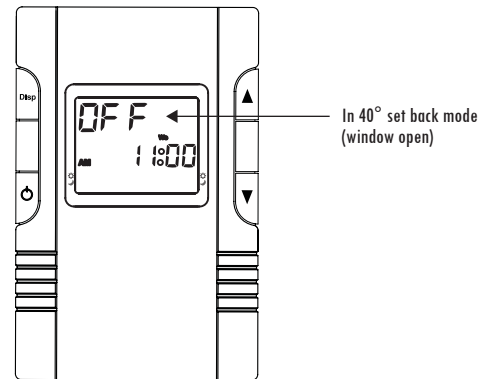

5 Motion Detector Interface

Optional connections to motion detectors can set back temperature to 40°F if put in line with the window circuit.

An optional second 60° set back is available and can be custom ordered for large projects so that windows set back to 40° and motion is set back to 60°. *Contact factory.*